



Sales Partner: **XPLORER BANGLADESH**



CATALOG

Non-toxic | Eco-friendly | High-efficiency



MOSQUITO



INSECTS



PIGEON



COCKROACHES



RATS

ABOUT US

Xplorer Bangladesh is the sales partner of **PITTARMAX**, a leader in pest control for over 20 years, specializes in the research and production of advanced solutions including:

- **LPG & CO2 Mosquito Traps**
- **Mosquito Zappers**
- **Solar Mosquito Killers**
- **Ultrasonic Insect Repellers**

Our integrated laboratory and R&D center ensure ongoing product innovation aligned with market needs. We remain dedicated to our mission of delivering **truly effective products!**



CORE TECHNOLOGY

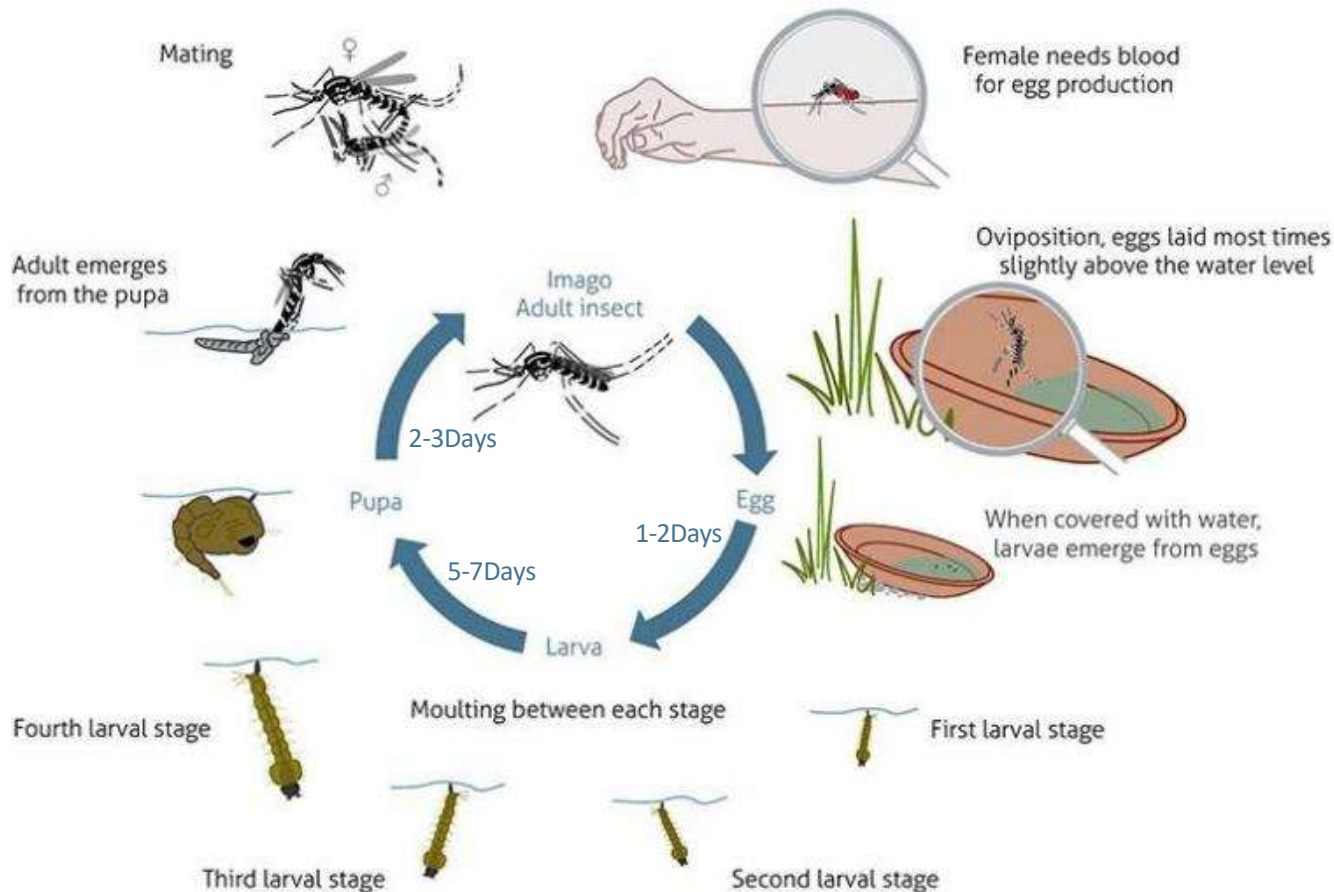

STAGE OF MOSQUITO

Most Aedes mosquitoes are fierce stinging bloodsuckers.

Female mosquitoes can suck blood both during the day&night. They usually start sucking blood 2-3 days after emergence.

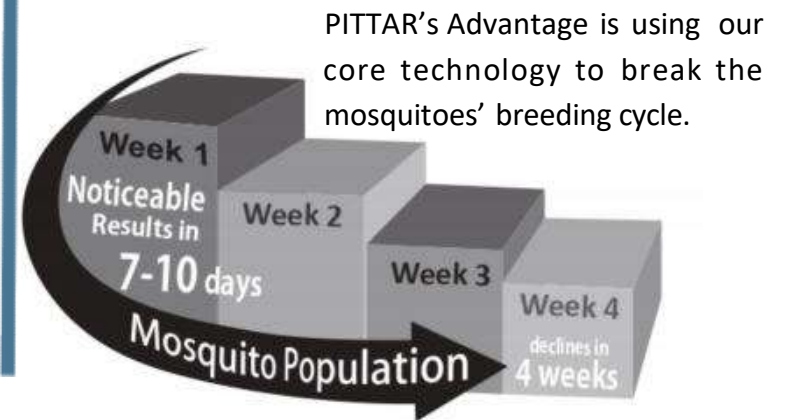

UNIQUE ITEM



PM3000

Size:51*64*58CM/Weight:11KG
Effective area: Over **3000M²**

Cordless design



Bait: CO2

Feature: Imitation of human body breath

Main ingredients of bait: lactic acid, CO2, mushroom alcohol



Convert Propane / LPG gas into CO2, heat and water vapor through the engine

Use the **smell** of baits combined with **heat** and **water** attract mosquitoes get close to the trap

Then the convection device sucks the mosquitoes into the **bug bag**

Finally dehydrates mosquitoes to death within **24** hours.



Specification of M3000

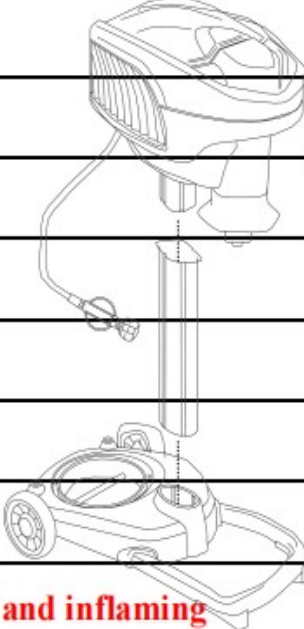

Model:	M3000	
Product Name:	Mosquito Trap with LPG Gas	
Weight:	16.5KG	
Carton size:	51*64*58cm	
Season:	All-Season 24h	
Applicable area:	above 3000 m²	
Power supply:	no need for electricity	
Material :	Plastic , ABS Material (waterproof and inflaming retarding)	



Baits: LureMax & Octenol

- Two types of bait can be used simultaneously or alternatively.
- Can be used about 21 days / 30 days once open.
- Can be stored at room temperature without opening about 12-18 months.
- Can be stored in refrigerator without opening about 5 years



LureMax



Octenol

Section 2. COMPOSITION / INFORMATION ON INGREDIENTS				
Chemical Name	Content	Cas No.	OSHA PEL	ACGIH TLV
Ammonium Bicarbonate	70%~90%	1066-33-7	N/E	N/E
Lactic Acid	1%~10%	79-33-4	N/E	N/E
1-Octen-3-ol	1%-10%	3391-86-4	N/E	N/E
Other inert ingredients:			N/A	N/A

Note: N/E = Not Established N/A = Not Available or Not Applicable

Kind reminder:
Baits need to be purchased separately.

◆ The ingredients of it are food grade.
◆ Have US EPA&MSDS of LureMax.



Maintenance of M3000

- Refill propane / LPG (with 24-hour /7-days operation.)
 - 10kgs tanks lasts about 21 days
 - 15kgs tanks lasts about 30 days
 - 20kgs tanks lasts about 42 days



- Replace Octenol every 21days or LureMax every 30days.



- Empty or replace bug bag when refill tank or replace attractant.



- Periodically wipe down the outside of the trap with a clean damp cloth.



Applicable Area&Effect

Applicable Area



Garden



Camping



Grass



Yard

Effect



Pest control

Mosquito Research

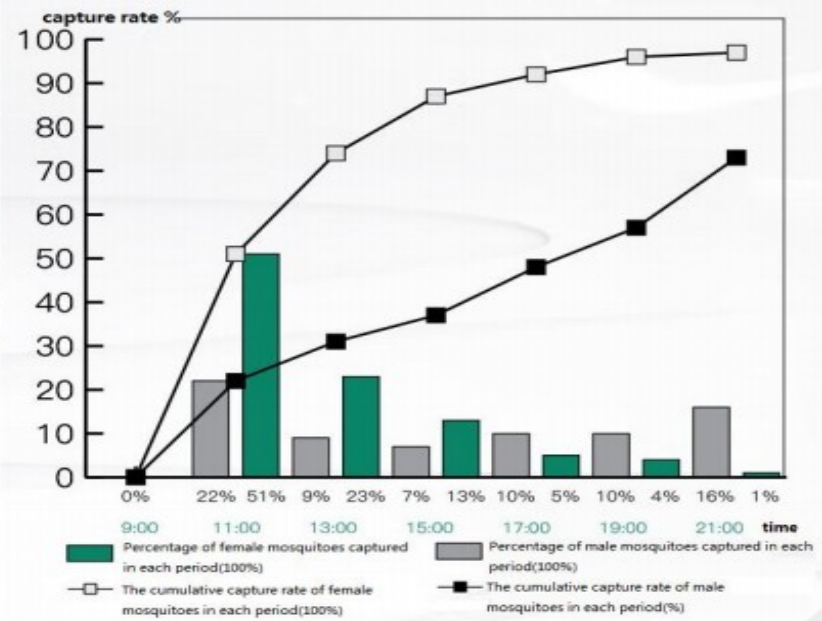

UNIQUE ITEM

DT9000

Size:32*32*63CM/Weight:8.95KG
Effective area: Over 1600M²



UV bulb generates warm light, which is highly attractive to many pest insects.

Bait produces a CO₂ trail that mimics human breath, which is irresistible to mosquitoes.

The powerful, whisper-quiet fan draws mosquitoes into the retaining cage (or mesh), then they would dehydrate and die within 24 hours.

OUTDOOR CO₂MOSQUITO TRAP

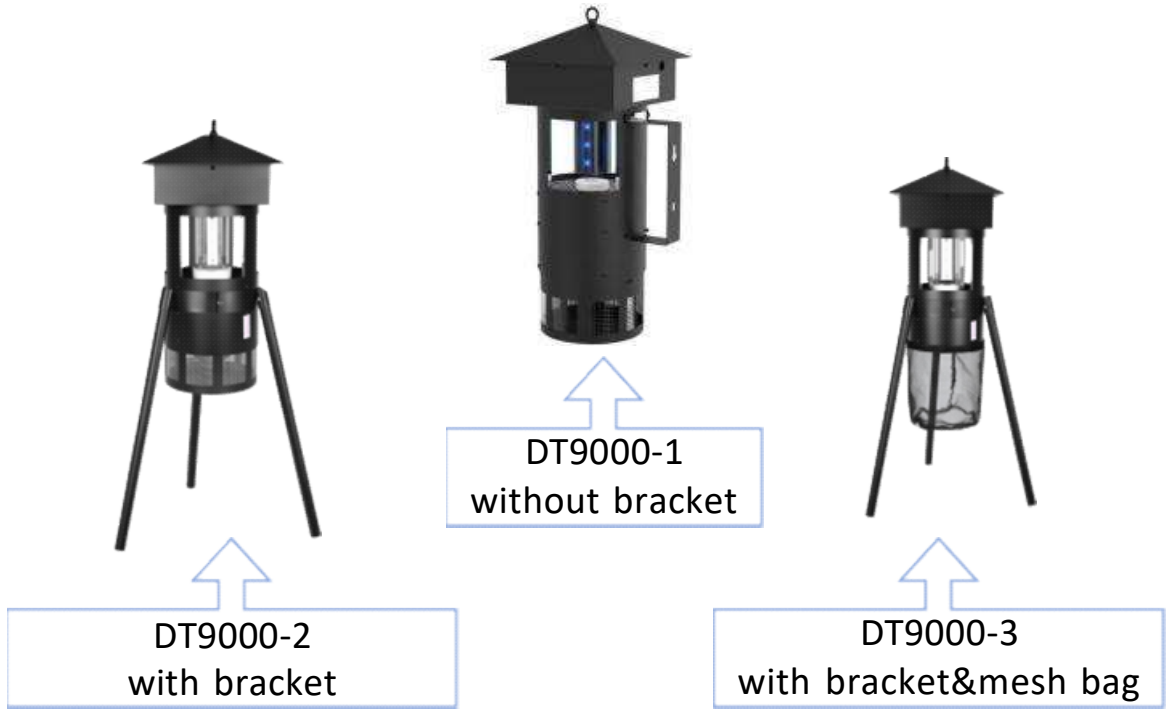

Bait: CO₂
Feature: Imitation of human body breath
Main ingredients of bait: lactic acid, CO₂, mushroom alcohol

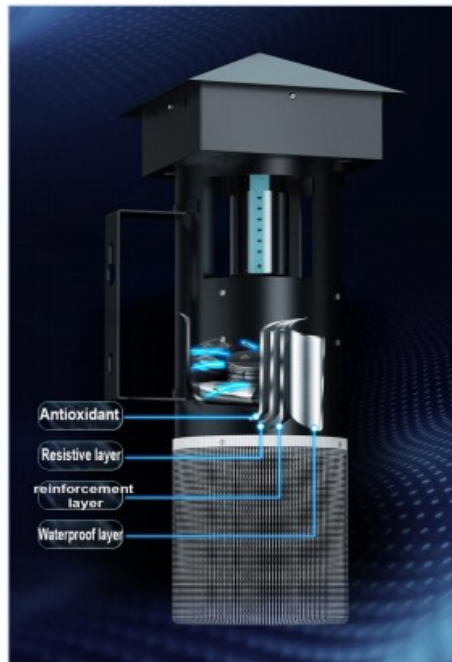

Model:	Outdoor- DT9000
Product Name:	CO ₂ mosquito trap
Material :	Stainless steel
Product size:	32*32*63CM
Weight:	8.95KGS
Fan motor:	220VAC, 0.23A, 50W
DC power:	12V, 1.0A, 12VA
Length of power cord:	5M
Lamp:	12VDC, 0.5A, 6W
Power supply:	Plug in
Effective area:	more than 1600m²
Material advantage:	waterproof, sun-proof, high temperature resistance



Use light & bait to lure mosquitoes

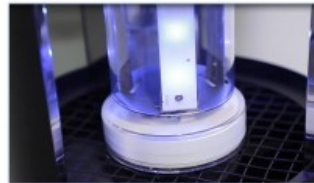

UV bulb generates warm light, which is highly attractive to many pest insects.

Bait produces a CO₂ trail that mimics human breath, which is irresistible to mosquitoes.

The powerful, whisper-quiet fan draws mosquitoes into the retaining cage (or mesh), then they would dehydrate and die within 24 hours.





Pest control

Bait&Maintenance of DT9000

Patent bait



- Remove the sticker from the surface, let the blowhole side face up.



- Can be used about 30 days once open
- Can be retained about 12-18 months if stored at room temperature without opening
- Can be retained about 2-3 years if stored in refrigerator without opening

Maintenance

- **Replace bait every 30days.**
- **Empty or clean storage cage or mesh bag.**



Effect of DT9000



Feedback of Effect:

- Using time: 2 days
- Using area: courtyard
- Effect: a few mosquitoes and moths



Feedback of Effect:

- Catch various kinds of pests
- Using area: farm
- Effect: Covered mesh bag more than 5 cm

Mosquito Research

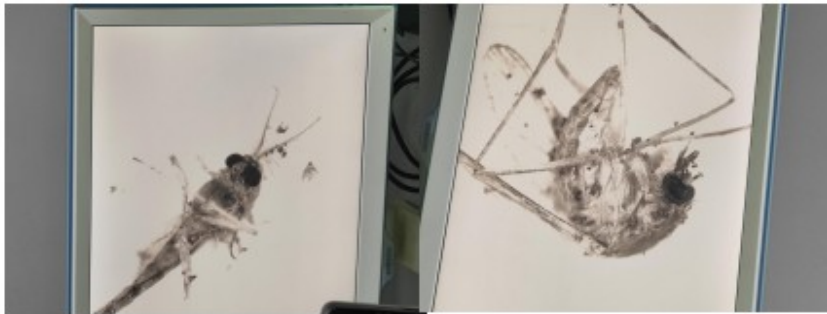

Culex Pipiens

They hide at home every day to suck blood. Their wings are large without any texture. They are brownish yellow and move at night. They spread filariasis and Japanese encephalitis



Midges

The adults are small, brown or black, about 1-4mm long, white and fierce, and touch out to spread Japanese encephalitis and human and animal filariasis



Aedes

With silvery white stripes, it is an important vector of dengue fever and mainly sucks blood on white days



anopheles

It is characterized by large and textured wings and gray body. It is an important vector of Malay filariasis and nocturnal activity



Specification of TM07



**Focus on quality
and win with details**

PRACTICE QUALITY AND DETAIL TO WIN

**365nm purple light
wave**

High brightness and long life



**Party escape
mosquito storage box**

Removable design, easy to
clean

**Anti-vibration
non-slip foot pad**

Effectively reduce operating
noise



Model:	PTM07
Product Name:	CO2 Airflow Mosquito Trap
Material :	Plastic(waterproof)
Product Dimension:	16*30cm; (Hook 4cm, Body 26cm, Width 16cm)
Weight:	0.8kg
Color:	Black
Carton size:	14*14*30cm
Season:	All-Season 24h
Application:	Outdoor/Indoor
Applicable area:	50-100m ²
Rated Voltage:	12V
Power Cord Length:	3M
Trapping Area Radius:	10m
Bait Ingredients:	Mixed with a variety of food grade additives which is harmless for human

Pest control

Principle of TM07

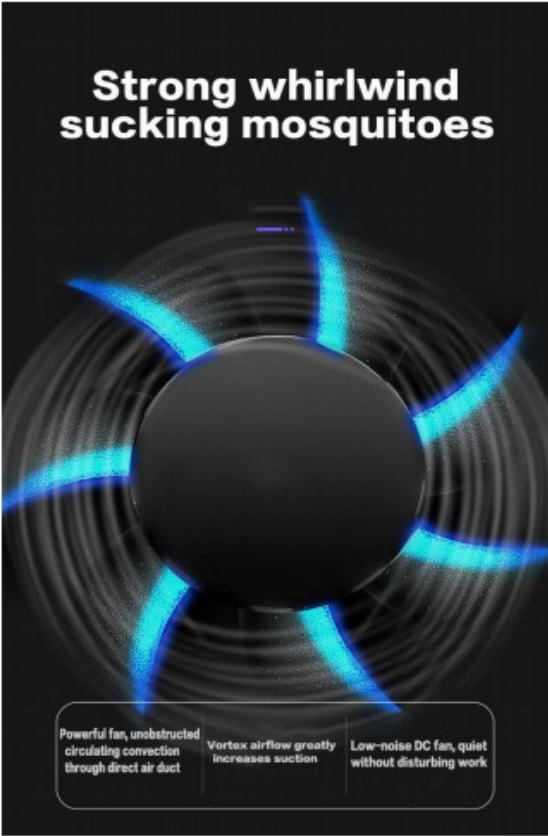
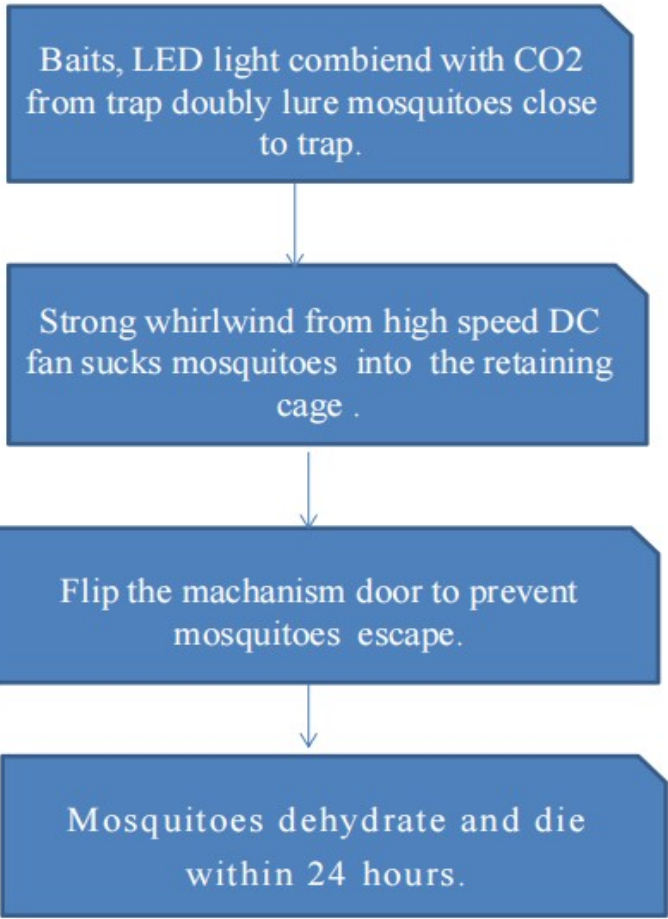

Pest control

Baits: MAX 01

- Ingredients : mixed with a variety of food grade additives.
- The Bait- Imitate the human body to emit CO₂ and lactic acid which is harmless for human body.
- Mother and baby can rest assured to use this kind trap with bait .
- Remove the sticker from the surface, let the blowhole side face up.
- Can be used about 30 days once open
- Can be stored at room temperature without opening.
- about 12-18 months Can be retained about 2-3 years if stored in refrigerator without opening

Kind reminder:
Baits need to be purchased separately.
◆ Have SGS&US EPA&MSDS of LureMax.

toxic free and safe



Maintenance Method

- **Clean the net every 30 days**
Throw away dead mosquitoes and clean the dust.
Re-insert net into trap after cleaning.



- **Clean the machine every 30 days**
There will be a layer of dust on the LED lights and fan after 2-3 months use of the machine, which will impact the effective. Please use the brush we provided to clean the dust on the fan and LEDs.



Caution: Top and bottom boxes align icons before normal power on.



- **Change the attract every 30 days.**



Turn off the machine before cleaning the net, machine and changing the attract.



Applicable Area&Effect

Applicable Area :Outdoor&Indoor



Effect: This kind trap Fits anywhere and mosquito catching effect is very great.Catching hundreds of mosquitoes every week, shown as below.

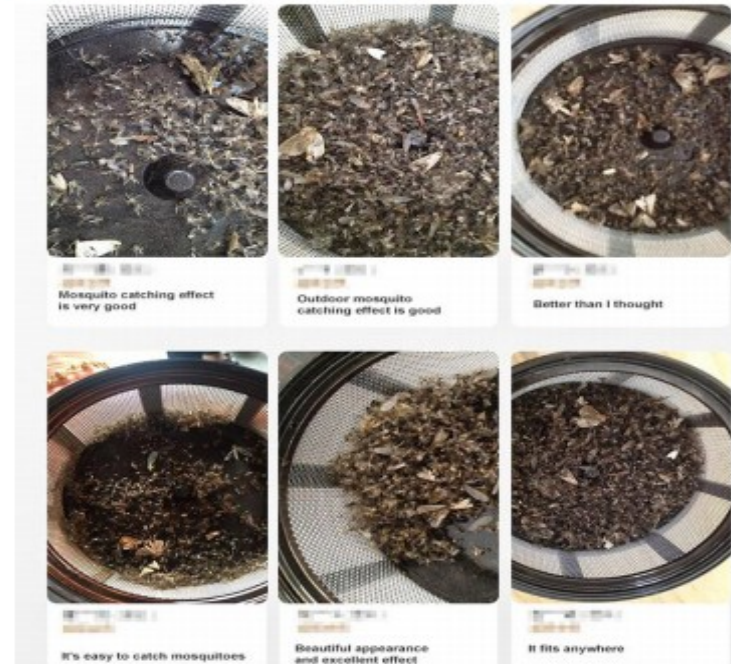

Mosquito Research



Q: Do you know how to catch the mosquitoes?
A: For safeguarding your living spaces from mosquitoes let's learn something about mosquitoes right away?

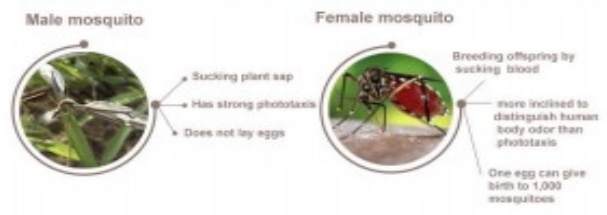

Tips: In daily life, blood sucking mosquitoes are female mosquitoes

Q: Why do most of the mosquito killers lamp on the market do Poor results?

A: Because most mosquito killers on the market don't have CO2 bait to attract mosquitoes ,specially the females which is beneficial for killing blood-sucking mothers.

Therefore,
 scientists invented a bait
 according to the habits of mosquitoes.



Specification of P001A and P001B



Model:	
P001A-indoor/TM04	P001B-indoor/TM05
Material:	
Aluminum alloy	Stainless steel(waterproof, sun-proof, high temperature resistance)
Application:	
Indoor	Outdoor
Applicable area:	
100-150m ²	100-200m ²
Dimension / Weight :	180*120*250mm /1.4KG
Colors:	Satin Nickel, Antique Copper, Black
Carton size:	20.5*20.5*29cm
Season:	All-Season 24h
Power Adaptor :	Input 100-240V, Output DC12V
Power Consumption:	3.5watts
Bait Ingredients:	Mixed with a variety of food grade additives which is harmless for human



Principle of P001A and P002B

Baits ,Warm and bright light from LED light combined with CO2 doubly attract mosquitoes close to the trap.

Strong whirlwind from high speed DC fan sucks mosquitoes into the retaining cage .

Flip the mechanism door to prevent mosquitoes escape.

Mosquitoes dehydrate and die within 24 hours.



Pest control

Baits: MAX 01

- Ingredients : mixed with a variety of food grade additives.
- The Bait- Imitate the human body to emit CO₂ and lactic acid which is harmless for human body.
- Mother and baby can rest assured to use this kind trap with bait .
- Open the attractant bag, take out the attractant, use a sharp object to penetrate the holes on cap(open as much as you could), and place the attractant into the trap.



Kind reminder:
Baits need to be purchased separately.
◆ Have SGS&US EPA&MSDS of LureMax.



Maintenance Method

- **Clean the retaining cage every 30 days**

Turn anti clockwise to open bottom box and remove net.
Throw away dead mosquitoes and clean the dust.
Re-insert net into trap after cleaning.



- **Clean the trap every 30 days**

There will be a layer of dust on the LED lights and fan after 2-3 months use of the trap, which will impact the effective. Please use the brush we provided to clean the dust on the fan and LEDs.



- **Attractant Replacement Time**

Can be used about 30 days once open. Replace the attractant and clean the trap every 30 days.
Can be stored at room temperature without opening.
About 12-18 months Can be retained about 2-3 years if stored in refrigerator without opening.



Turn off the trap before cleaning the retaining cage, trap and replacing the attractant.



Applicable Area

P001A- indoor



Trap hanged on big solar Panel will be charged more quickly and more effectively.

P001B -outdoor

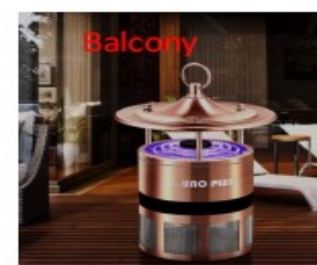

Effect



Indoor Testing Result:
Catching more than 100 pcs mosquitoes every week.



Outdoor Testing Result :
Catching almost 300pcs mosquitoes every week.



PATENT ITEM

CO2 MOSQUITO TRAP

Working Principle:

delivery powerful 3-way protection against mosquitoes with 365nm light wave , CO2 bait and whisper-quiet fan.



P001A/B

Size:20.5*20.5*29CM
Weight:1.38KG
Material: Aluminum alloy/
Stainless steel



P002

Size:19.5*15.5*30CM
Weight:0.94KG
Material: plastic



P003

Carton size: 14*14*30CM
Weight:1.45KG
Material: plastic



TM07

Size:14*14*30CM
Weight:1.7KG
Material: plastic



P001D

Size:145*35*65CM
Weight:12.7KG
Material: Stainless steel



Bait: CO2

Feature: Imitation of human body breath

Main ingredients of bait: lactic acid, CO2, mushroom alcohol

HOT SALE ITEM

MOSQUITO KILLER LAMP

Working Principle:

365nm UV wave length lures mosquitoes



HS serie

Material: Aluminum alloy

Power: LED 6/8/10W

GLASS TUBE 20W/30W/40W



HAP60 serie

Material: Aluminum alloy+ABS

Power: LED 6/8/10W

GLASS TUBE 20W/30W/40W



HP70 serie

Material: Plastic

Power: LED 6/8/10W

GLASS TUBE 20W/30W/40W



3-tube serie

Material: Aluminum alloy+ABS

Power: GLASS TUBE 30W/45W/60W



sticky trap serie

Material: Aluminum alloy+ABS

Power: GLASS TUBE 20W/30W/40W

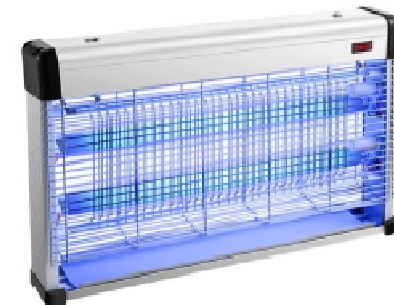

A78

Material: Aluminum alloy+ABS

Power: GLASS TUBE 20W/30W/40W

OUTDOOR ITEM

OUTDOOR/SOLAR MOSQUITO KILLER

Working Principle:
365nm UV wave length lures mosquitoes



90ZN-20W/110ZN-30W/140ZN-40W

Material: Aluminum alloy+ABS
COLD-CATHODE TUBE



184-30W/204-40W

Material: Aluminum alloy+ABS
COLD-CATHODE TUBE



90ZN-20W/110ZN-30W/140ZN-40W(with bracket)

Material: Alum-40Winum alloy+ABS
COLD-CATHODE TUBE



279-30W/299-40W

Material: Aluminum alloy+ABS
COLD-CATHODE TUBE



Product details

OUTDOOR ITEM

OUTDOOR MOSQUITO KILLER

Working Principle:
365nm UV wave length lures mosquitoes

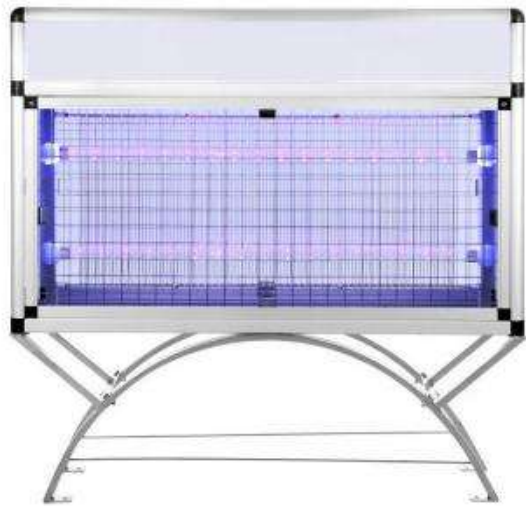

690L/760L/840L

Material: Aluminum alloy+stainless steel
Power: 20W/30W/40W/80W



690/760/840(3 tubes)

Material: Aluminum alloy+stainless steel
Power: 54W/90W/108W



Product details

OUTDOOR ITEM

OUTDOOR/SOLAR MOSQUITO KILLER

Working Principle:
365nm UV wave length lures mosquitoes



060

Weight: 7.66KG
Size: 30.5*67CM



Z2

Machine weight: 7.42KG
Solar panel weight: 6.8KG
Size: 18*67*110CM



085

Material: Die-casting+stainless steel+Q35 steel
Size: 21*87CM



G2

Material: Q235 steel
Size: 76*41*30CM



G4

Material: Q235 steel
Size: 66.5*82*17CM



087

Material: Die-casting+stainless steel + Q35 steel
Size: 35*45*100CM

SOLAR ITEM

SOLAR MOSQUITO KILLER

Working Principle:

365nm UV wave length lures mosquitoes

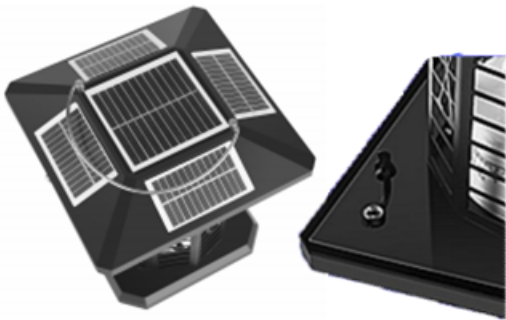

(Multiple designs.....)

Model	Product type	Weight	Size
HJ-ST135	Portable type	1.9KG	20.5*20.5*25.5CM
HJ-ZT145	Pillar head type	2.0KG	20.5*20.5*30.5CM
HJ-BG145	Wall-mounted type	2.0KG	20.5*20.5*30CM
HJ-CD145	Insert type	2.3KG	20.5*20.5*77CM
HJ-CP175	Lawn type	3.1KG	20.5*20.5*50CM





**LPG & CO2 Mosquito Trap / Mosquito Zappers
Solar Mosquito Killer / Ultrasonic Insects Repeller**



Welcome to Join Us & Grow Together!

Sales Partner: XPLOER BANGLADESH

www.xplorer.com.bd | TEL: 0088 01819276407 | Email: farid@xplorer.com.bd